



XACT METAL

DESIGN GUIDE

**BEST PRACTICES FOR
METAL POWDER-BED FUSION
ADDITIVE MANUFACTURING**

xactmetal.com

CONTENTS

- 3 | Overview
- 4 | Applications
- 5 | Technical Capabilities
- 6 | Pre-Processing
- 7 | Process Flow
- 8 | Manufacturing Capabilities
- 9 | Manufacturing Considerations
- 10 | Design Guidelines

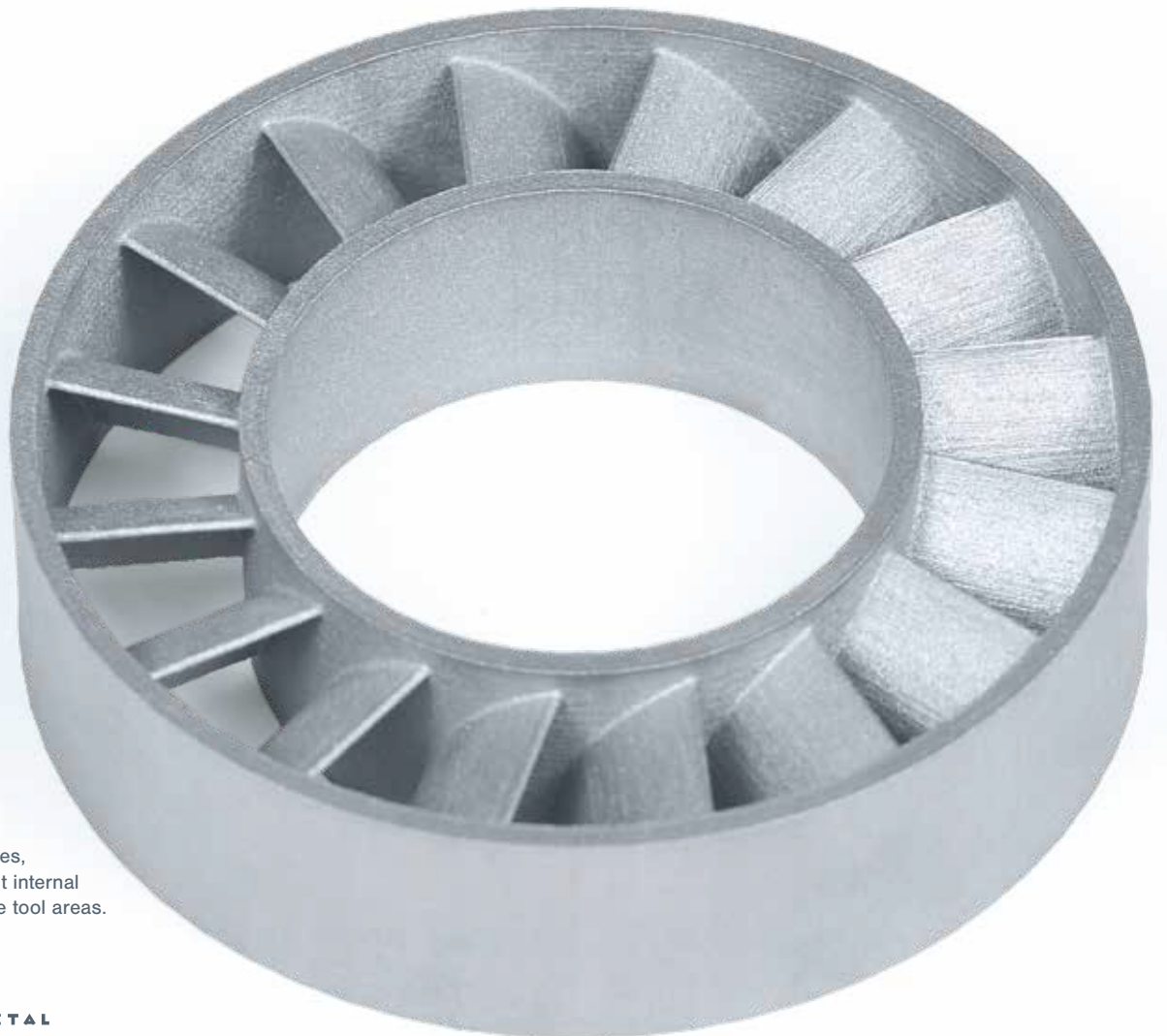

STATOR

Stator with sloped surfaces, overlapping features, tight internal corners, and inaccessible tool areas.

OVERVIEW

Additive Manufacturing machines build near-net-shape 3D components from Computer Aided Design (CAD) data. Compared to traditional machining and assembly processes, additive manufacturing significantly simplifies manufacturing and can produce components with highly complex features and all-in-one assemblies.

Metal Powder-Bed Fusion—also known as Selective Laser Melting or Direct Metal Laser Sintering—is an Additive Manufacturing process using a laser to melt consecutive layers of a metal powder-bed. The powder fuses into the finished dimensional part incorporating complex internal and external geometries.

Metal Powder-Bed Fusion (Metal PBF) produces highly dense components and reduces total build cycle time by over 50%, eliminating the need for wash/debinder and sintering equipment used in bound metal deposition, atomic deposition additive manufacturing or other FDM-like metal 3D printers.

METAL POWDER-BED FUSION BUILD PROCESS

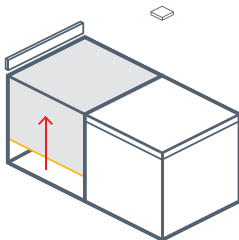

POWDER FEED
Feed cylinder increments up placing powder in front of the recoater.

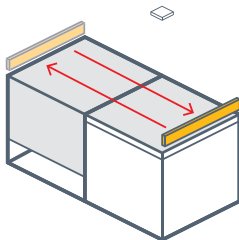

ADDING POWDER LAYER
Recoater moves across the feed cylinder delivering powder to the build cylinder.

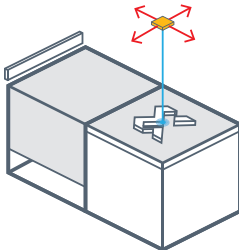

FUSION
Laser fuses the cross section of the part.

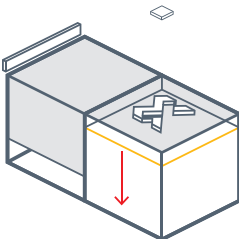

BUILD CYLINDER
Build cylinder increments down one thickness layer.

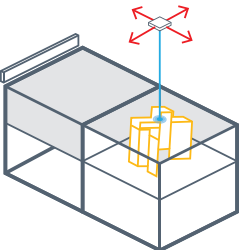

COMPLETING THE BUILD
The process is repeated until the volume of the part is fully built.

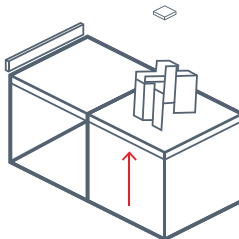

BUILD PLATE AND PART REMOVAL
The build cylinder raises up and the build plate is removed.

APPLICATIONS

RAPID DESIGN PROTOTYPING

Rapid build of engineering design samples and manufacturing prototypes minimizes the timeline to move from engineering design to full production. By eliminating the set-up and tooling costs necessary in traditional manufacturing processes such as casting and machining, Metal PBF can produce finished prototypes with typical build times of 12 to 36 hours and allow rapid design modifications.

ONE-OFF MANUFACTURING

Minimizes manufacturing expense and time for one-off applications such as machine shop tooling for injection molding or die casting. Enables rapid printing of student-generated designs in college classes and graduate work.

COMPLEX DESIGNS

Allows manufacture of difficult-to-machine parts, such as components with long or partial thru-holes, internal cavities, contours and tapered geometries, and metal mesh or lattice structures. Conformal cooling channels can be printed in tooling; the design should ensure that supports are not required, and that there is a practical way to remove any excess powder.

ALL-IN-ONE ASSEMBLIES:

Enables printing of complete assembled components, eliminating the machining and assembly (often welding) cost of multiple components.

REMOTE MANUFACTURING

Enables remote manufacturing by allowing on-site build of critical replacement components from digital CAD files.

REDUCES PHYSICAL INVENTORY

Replaces physical inventory cost and space with digital 3D CAD files. Components are rapidly and easily printed on-demand from the CAD files.



PENCIL THRUSTER

All-in-one pencil thruster illustrating multiple part consolidation into single printed part.

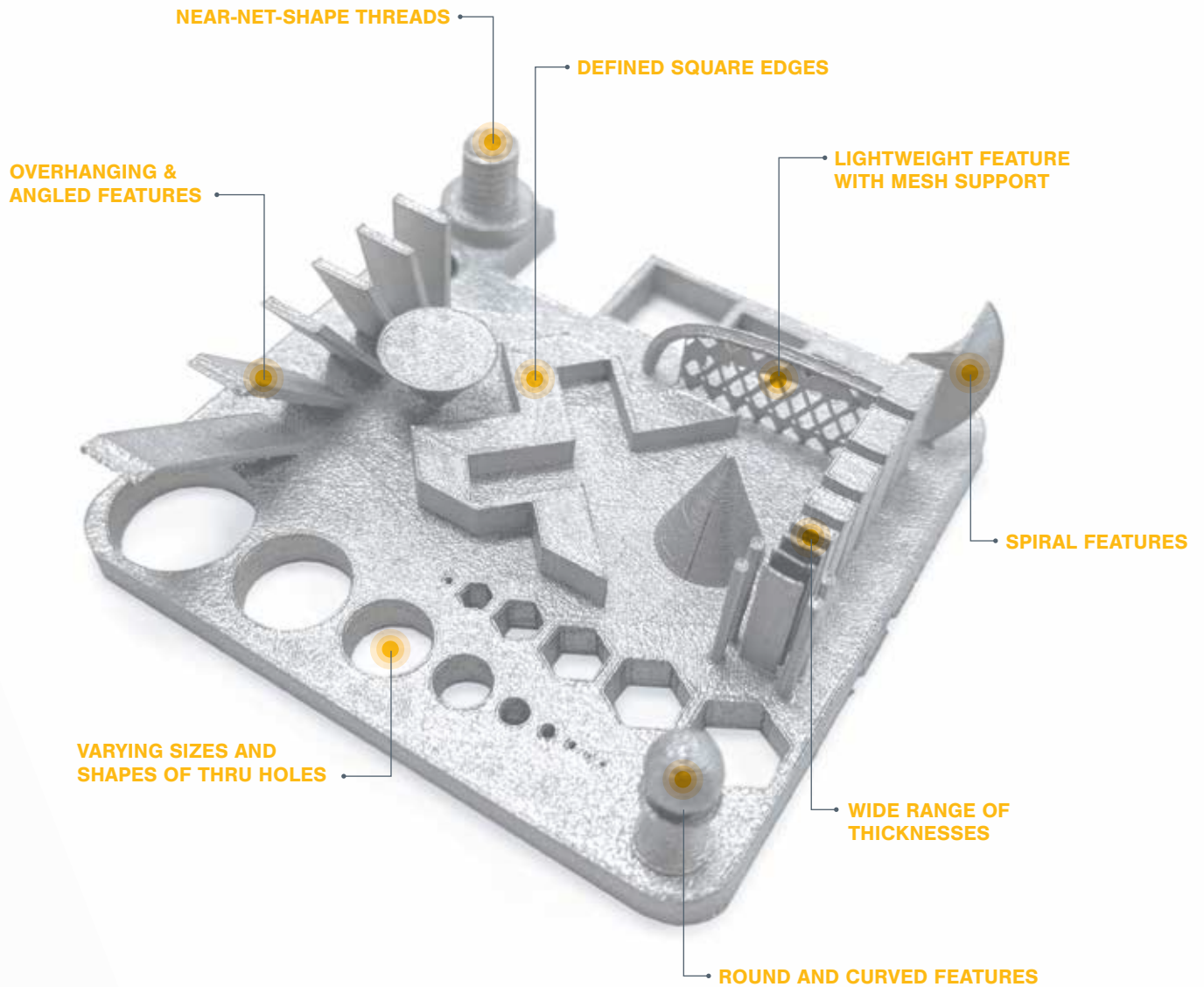

TECHNICAL CAPABILITIES

Metal Powder-Bed Fusion enables manufacturing of complex geometries with many features not readily obtainable by conventional subtractive manufacturing processes such as machining and casting.

PRE-PROCESSING

The component is modeled in 3D CAD software. The CAD model is then loaded into additive manufacturing pre-processing software which generates the toolpaths for the printer. This effectively replaces the CAM software found in traditional CNC machining.

The pre-processing software takes the 3D model and slices it into the layers that will be printed. The software then generates the toolpaths for the laser, which will fuse the individual layers of powder. The build file is then loaded onto the printer. Also included in the build file are the process parameters, such as travel speed and laser power. The machine executes this file to build the 3D part.

In addition to generating the toolpaths, most popular pre-processing software packages also allow some manipulation of the 3D file, location of the part to be adjusted, and creation of support structures.

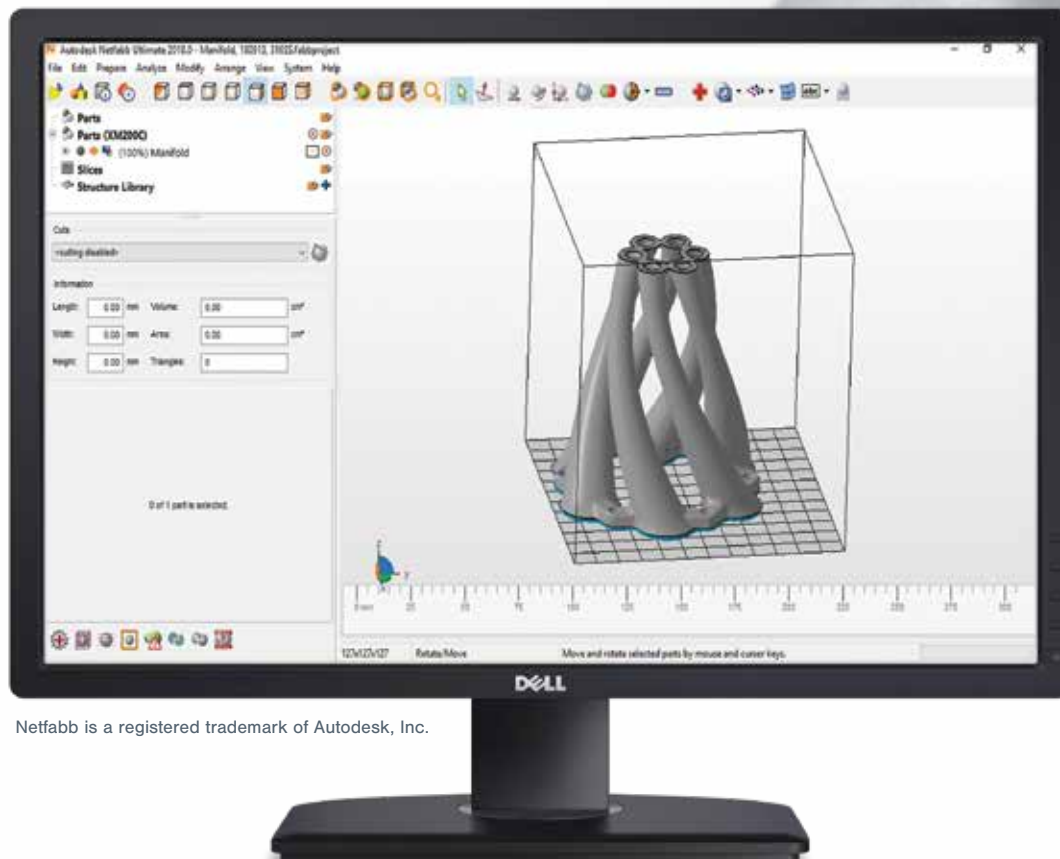

MANIFOLD

Manifold with curved channels.

Netfabb is a registered trademark of Autodesk, Inc.

PROCESS FLOW

Printing of complex 3D parts with metal powder bed fusion is a straightforward process with total build and processing times of 8 to 36 hours.

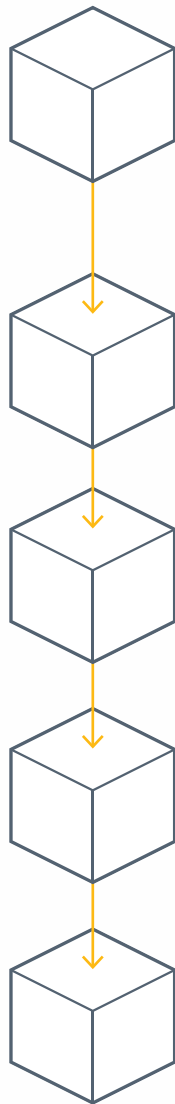

1.

PRE-PROCESSING

- Optimizing CAD build file for additive manufacturing
- Support generation
- Slicing
- Selection of Scanning Strategy

2.

BUILD PREPARATION

- Loading build file
- Preparing build volume and adding metal powder

3.

BUILDING

- Precision controlled fusion of the metal powder into layers that form the desired shape and volume

4.

SEPARATION OF PART FROM BUILD PLATE

- Removal of part from build plate with wire EDM, bandsaw, or flush cutting tool

5.

POST PROCESSING

- Removal of supports
- Final surface finishing
- Heat treating for mechanical properties

MANUFACTURING CAPABILITIES



TYPICAL METALS USED IN METAL PBF APPLICATIONS

- Stainless Steels: 316L, 17-4 PH, 15-5 and 400 series
- Super Alloys: 625, 718, Cobalt Chrome F75, and other Nickel, Chromium & Molybdenum based alloys
- Tooling Steels: Maraging M300 and H13
- Bronze and Copper
- Aluminum AlSi10Mg
- Titanium Ti 64
- Precious Metals (Gold and Silver)

BUILD TOLERANCE*

- Part Dimensions <30 mm (1.18 in.): +/- 60 microns (+/- 0.0024 in.)
- Part Dimensions >30 mm (1.18 in.): +/-0.2%

*Tolerances of 20 to 50 microns (0.001 to 0.002 in.) achievable after process optimization for a given geometry.

IMPELLER

Difficult to machine Impeller with multiple complex surfaces.

MINIMUM SIZES

- Minimum practical wall thickness: 100 microns (0.004 in.)
- Minimum practical hole size: 200 microns (0.008 in.)

FEATURE SPACING

Allow minimum of 0.5 mm (0.020 in.) between adjacent features.

FLATNESS

Dependent on thickness of additively manufactured component. Thin sections may distort on printing and require a thermal or mechanical stress relieving cycle.

SURFACE FINISH

Dependent on build orientation and material; typically, better than as-cast.

MECHANICAL PROPERTIES

Tensile value, elongation, modulus of elasticity, and hardness properties comparable to forged or cast properties.

ALL OF THESE FEATURES CAN BE OPTIMIZED BY ITERATION OF THE BUILD PARAMETERS.

MANUFACTURING CONSIDERATIONS

MANUFACTURING QUANTITY

Additive Manufacturing is typically a low-quantity process. Manufacturing components with established designs, in higher quantity, is more efficient and less costly with traditional processes like casting, machining, and assembly.

Two important exceptions where Metal PBF offers distinct advantages:

- Manufacturing of complex designs that incorporate difficult-to-machine features such as complex internal geometries or mesh structures
- Manufacturing of small run, custom parts

BUILD SIZES

The build volumes of Xact Metal printers range from:

- 12.7 cm. cube (2048 cu-cm.) / 5-inch cube (125 cu-in) to
- 25.4 cm. x 33 cm. x 33 cm. (27660 cu cm.) / 10 in x 13 in x 13 in (1690 cu-in.)

REACTIVE METALS

Special handling and processing should be used when printing reactive metals such as titanium and aluminum.

BUILD PLATE

Metal PBF components are fused to a supporting build plate to prevent movement or warping during printing. Build plate material should be metallurgically compatible with the powder metal to minimize distortion during printing.

POST PROCESSING (AS REQUIRED OR SPECIFIED)

- Removal of the printed component from the build plate with a bandsaw, wire EDM, or flush cutting tools
- Removal of supports
- Traditional finishing processes such as grinding and polishing, finish machining, bead blasting, and abrasive slurry honing of internal channels
- Tumbling, wet-blasting, and dry-blasting
- Post treatment processes including heat treat annealing and Hipping
- Resurfacing of build plates

INJECTION MOLD

Injection Mold with internal channels and tough-to-machine slots.



DESIGN GUIDELINES

Design of components for Metal PBF manufacturing requires consideration of several key guidelines. 3D CAD programs such as AutoDesk Netfabb® and Materialise Magics have features to assist in your design including modules devoted to Additive Manufacturing.

HEIGHT:WIDTH RATIO

Tall, narrow features should have a maximum height:width (aspect) ratio of 8:1. Features with greater aspect ratios risk damage by the recoater during powder application. Adding a gusset to the component design will strengthen the feature and minimize damage.

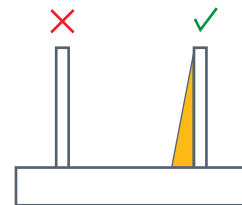

OVERHANGING SURFACES

- 0 to 30 degrees: Need supports
- 30 to 45 degrees: Supports not needed but part may have poor surface on down facing surfaces
- Greater than 45 degrees: Supports not needed; good quality surface finish



FLAT CEILINGS

Flat ceilings larger than 1 mm (0.04 in.) will require a solid or mesh support. Fillets can also be added to prevent warpage out of the build plane.



GEOMETRY SUPPORT STRUCTURES



Solid or mesh mechanical supports can be added to optimize anchoring, minimize wall distortion from thermal gradients, support overhanging geometry, and provide solid anchoring between the component and the build plate to eliminate component movement during printing. The supports are removed after separation of the component from the build plate. Extra care should be taken when removing supports from thin walled parts; the process of removing the supports could potentially warp the parts.

HORIZONTAL HOLE SIZE AND SHAPE

Horizontal holes with diameters less than 5 mm (0.2 in.) can be printed reliably without internal support. Larger holes will require an internal mesh support or design change. Changing to a tear drop, oval, or square shape will eliminate the need for internal supports.

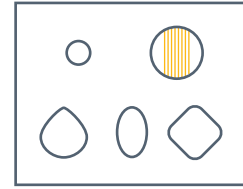

MINIMUM WALL THICKNESS

Typical minimum wall thicknesses range from 100 to 200 microns (0.004 to 0.008 in.).



POWDER ESCAPE

Holes are required to allow powder to escape from enclosed printed structures. A minimum hole diameter of 3.0 mm (0.12 in.) is recommended. Multiple or larger holes will increase the speed of powder removal.

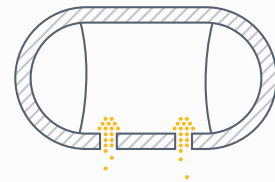

OTHER RECOMMENDATIONS

- Add fillets to decrease stresses at geometry changes
- Minimize unnecessary blocks of printed material
- Parts with large solid volumes (~10 cm³/4 in³) could require a thicker build plate to minimize warpage
- If practical, print internal holes parallel to the build direction (Z-axis)

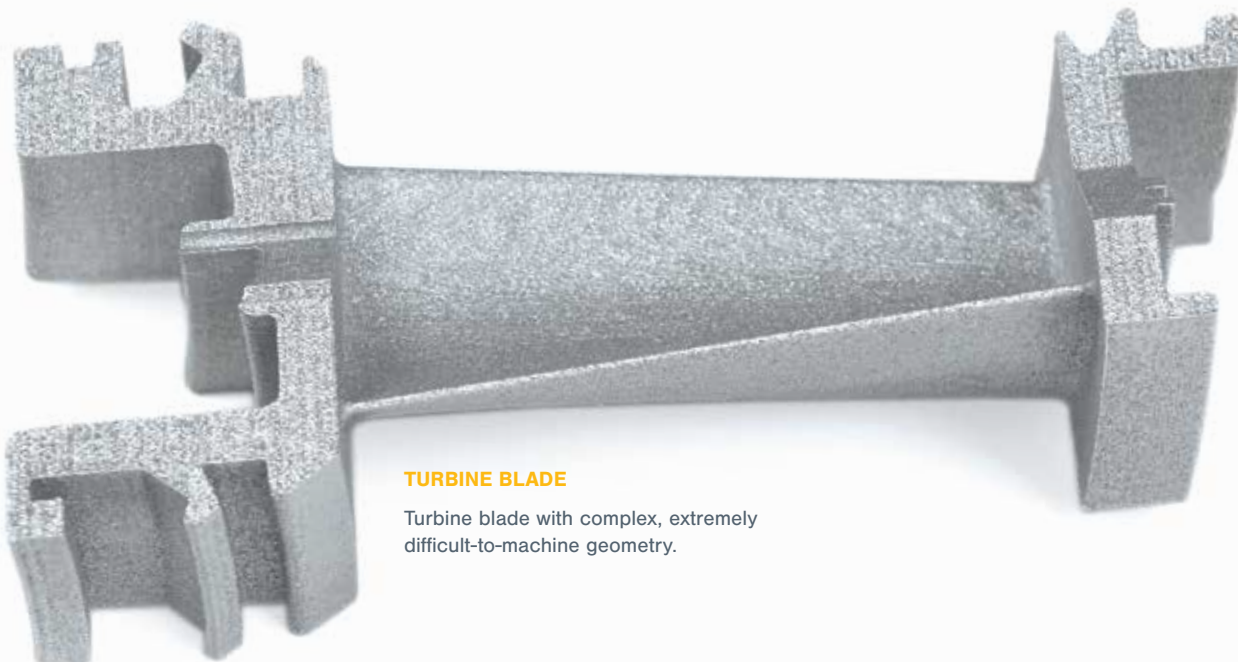

TURBINE BLADE

Turbine blade with complex, extremely difficult-to-machine geometry.



RESOURCES AT XACT METAL

Contact Xact Metal design and application experts at:
+1(814) 205-1505 or info@xactmetal.com.



xactmetal.com